

Instruction Manual - PH SlimLine



Model

- PH Slimline



THESE INSTRUCTIONS SHOULD BE READ CAREFULLY
AND RETAINED FOR FUTURE REFERENCE. BE SURE
TO OBSERVE ALL LABELS AND WARNINGS ON THE
APPLIANCE

Id.-Nr. 900 370 401

Edition :01/18

1. PRESENTATION

First of all, we would like to thank you for having bought this product; we hope that it will give you years of reliable heating. Before installing the heater, please read the following instructions carefully. The company is not responsible for any damage or problems resulting from incorrect installation. Once your heater is up and running, please store this booklet in a safe place for future reference.

RECYCLING

When you no longer need this heater, please follow the European Directive 2002/96/CE as regards its disposal. This heater cannot be discarded as normal rubbish. It must either be taken to a special tip or to a distributor offering to dispose for you. Recycling electrical appliances separately allows component parts to be re-used and limits the damage to the environment that would otherwise occur. Recycling saves power and resources. To encourage this, the heater bears a symbol showing it cannot be put into a normal bin. For further information, get in touch with your local council, or the supplier who you purchased this product.



VERY IMPORTANT!!

It is possible that the radiator may make slight sounds during the first days of operation. This is quite normal in dry radiators and can occur when the aluminium elements expand and contract. Please note there is no danger to the user. Children under 3 years old should be kept out of the equipment unless they are constantly supervised. Children under 8 must only turn on / off the device provided in normal position and only if they have received instruction concerning use of the equipment in a safe way and understand the risks. All children under 8 years should not plug regulating, cleaning or maintenance operations.

Caution: some parts of this product may become very hot and cause burns. Special attention when children and vulnerable people are present. The device must not be covered and air circulation must be allowed at all times.

2. HOW TO USE YOUR ELECTRIC RADIATOR

Understanding the full programming potential of your radiator will help to reduce energy consumption.

- DISPLAY

The radiator has an electronic programmable thermostat with LCD screen specially designed to control different types of heating options.

1. Operating mode menu (all active modes are framed).
2. Program number or parameters number.
3. Installation parameter menu.
4. Key lock function indicator.
5. Room temperature indicator.
6. Type of time display (12H am/pm or 24H)
7. Graphic view for the current day program.
8. Display zone for Time, Temperatures and parameters.
9. Heating demand.
10. Pictogram for program creation, status in normal mode.
11. Pictogram for pilot wire indication.
12. Current day of the week
13. Override function in AUTO mode or ITCS function activated if blinking.
14. Windows open indicator.

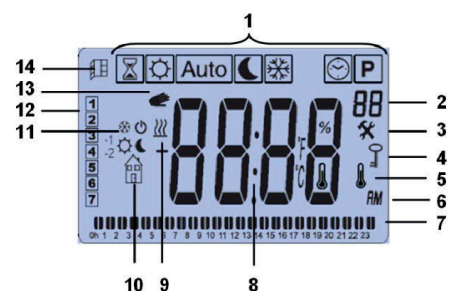

- KEYBOARD

1. On/Off
2. Minus Key -
3. Validation Key OK
4. Plus Key +
5. Right Navigation key



-

OK

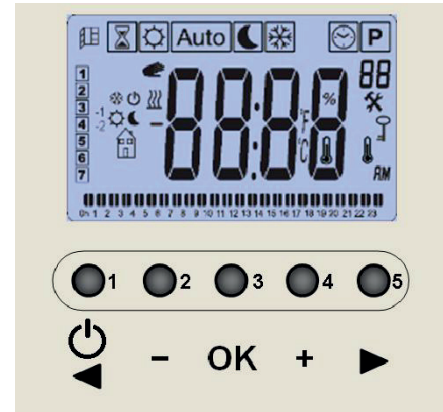

3 FIRST INSTALLATION

This section will help guide you to starting your thermostat for the first time.

- POWER SUPPLY

Connect the electric radiator with the switch installed for this function.

When the thermostat is switched on for the first time, you will be asked to make some necessary selections (Clock, etc.). The batteries inside the thermostat will need to be charged for a minimum of 24 hours in order to have maximum time saving capacity.

Now your thermostat will require adjustment of the time and date.

- TIME AND DATE ADJUSTMENT

First move the square cursor on the clock mode, then press the key (-) or (+) to start the adjustment. Each time a value blinks, you can adjust it with the (-) and (+) keys.

Once the value is chosen, confirm it with the (OK) key. The thermostat will move automatically to the next value. List order of the time and date adjustments:

1. Time and day:

- Adjustment of the hours,
- Adjustment of the minutes
- Adjustment of the day (1 = Monday)

2. Date:

- Adjustment of the day number
- Adjustment of the Month (01=January, 12=December)
- Adjustment of the Year

- STARTING

The thermostat is now ready to work. The default working mode will be comfort. At any time, when the light is off, press the OK, "-", "+" or right arrow. Press OK and then press the second time to show the fixed temperature.

- ON/OFF

Press key power if it is available on your radiator to turn off or turn on the radiator, Navigate to this key using the (right arrow) scroll key to select mode power. Select OFF to turn the radiator to the off position.

MODES OF OPERATION

How to change the working mode?

- Use the navigation key right (▶) (in some models also you can use the key left ◀) or to display the working mode line.
- Move the frame cursor on the desired working mode and press (OK) to enter in the operating mode you have chosen.

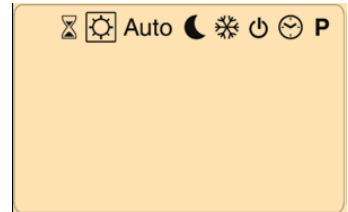



- **MANUAL MODE COMFORT** 

Manual working mode, the comfort temperature setting will be followed 24 hours a day / 7 days a week. By pressing (-) or (+) keys, the temperature can be adjusted accordingly.
- **MANUAL MODE REDUCED** 

During manual working mode the reduced temperature setting will be followed 24 hours a day / 7 days a week. By pressing (-) or (+) keys, the temperature starts to blink and can be adjusted.
- **OFF MODE** 

This mode only is selectable on radiators without an On/Off button. On radiators with an On/Off button, press this key to turn Off. Use this mode if you need to switch off your installation. Be careful: in this mode your radiator can freeze.
- **AUTOMATIC MODE** 

With this mode the thermostat will follow the chosen program (Built-in or customised) according to the actual time and the Comfort and Reduced temperature settings. You can easily override the current program temperature by changing the value with (-) or (+). The current setting temperature will blink. The small hand logo  will be displayed when the override function is active. The original temperature settings will return when the timer reaches the next change in the programme. If hand logo  blinks then ITCS is active (See the user menu for more explanation on this function).
- **ANTIFREEZE MODE** 

Use this mode if you want to protect your radiator against freezing when going on holiday... The anti-freeze setting temperature is fixed and can be adjusted in the parameter menu number 05 'AF', see chapter 6. (Default value 5°C)

If you want to stop the timer function before the end, set the duration period to "no" with (-) key.
- **TIMER MODE** 

The Timer mode allows you to adjust the temperature and the duration for a specific time.

 - This function can be used when you stay at home for several days, or if you want to override the program or some time.
 - You can first adjust the duration in hours "H" if below 24H, then in days "d" with (-) or (+), press (OK) to confirm. (Adjustable from 1 hour up to 44 days)
 - You can also adjust the desired setting temperature to start the function. (Default value 21°C).

The logo  will blink and the number of hours /days remaining is displayed until the end of the period.

5. PROGRAMMING WEEKLY



Select the mode with the keys of displacement

When you enter in the Program mode, the first operation is to choose the program number using the (-) or (+) keys. You can choose between a built-in program P1 to P9 or an user program U1 to U4. Select a program and press ok to validate.

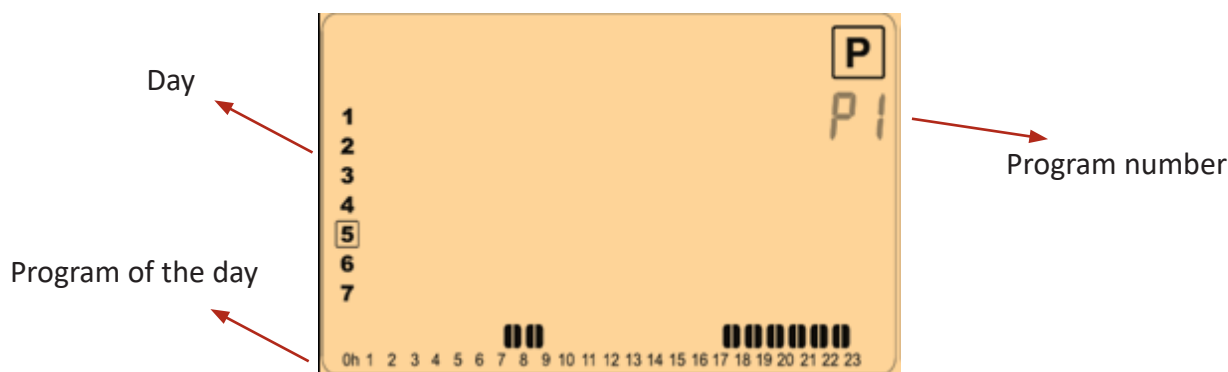

GB

If you select a built-in program P1 to P9, you can view and select only one of the following pre-set program options.

- P1: Morning, Evening & Weekend
- P2: Morning, Midday, Evening & Weekend
- P3: Day & Weekend
- P4: Evening & Weekend
- P5: Morning, Evening (Bathroom)
- P6: Morning, afternoon & Weekend
- P7: 7H – 19H (Office)
- P8: 8H – 19H & Saturday (Shop)
- P9: Weekend (Secondary house)

The bars indicate the hours with comfort temperature and the rest of the day the spaces represent the eco (reduced) temperature mode. (See the appendix section to view a complete description of the Built-in program)

- Use the navigation key right (▶) to view the program of alternative days of the week.
- Press the (OK) key to confirm your choice and return to the main screen (in AUTO mode)
-

If you select a user program U1 to U4 as mentioned above you can choose the program, view it and also amend it.



Default setting:

- U1, U2, U3, U4 = in comfort for the week
- Press the confirmation key (OK) to customise a user program

Description of the creation of a user program:

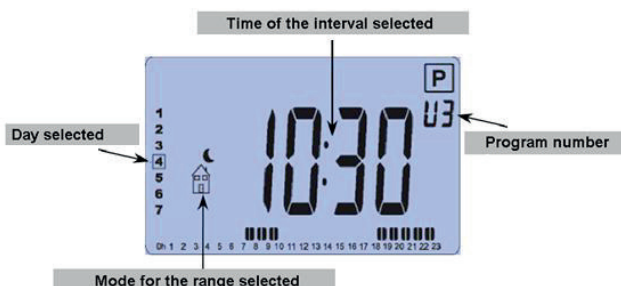
- The program step is 30 minutes
- Each time a value or icon blinks you are invited to make a choice with the (-) or (+) keys. Once the choice is made press the (OK) key to jump to the following step.



- The program creation will always start with day 1 (Monday).
- The key (-) activates the ECO  temperature mode to begin.
- The key (+) activates the COMFORT  temperature mode to begin.
- Use the (-) or (+) buttons to select the duration of the ECO and Comfort temperature modes in intervals of 30 minutes.
- When you have completed the first day the programme will automatically move to the next day. After validating the seventh day, the system automatically returns to AUTO mode and your programme mode will appear in the top right corner. For extra assistance, please contact the seller for a step by step guide.

6. SPECIAL FUNCTIONS

- KEYBOARDS LOCK FUNCTION: 

Use this function to prevent any changes to your settings (In a child room, public area, etc...)

To activate the Key lock function, first press and maintain the validation key (OK) and then press simultaneously on the right arrow key ().

- The “ ” logo will be displayed on the screen.
- Repeat the same procedure to unlock the keyboard.

Note: The keyboards lock function is available in all modes.

- FUNCTION WINDOWS OPEN 

This function will stop the radiator automatically when it detects a window open if the

radiator is running. When this feature is enabled, the  icon appears at the top left of the screen. If the system detects a fall of approximately 3 °C, it stops the heating for a period of 1 hour. The icon will blink and the temperature will be measured by the radiator. Pressing any button at this stage will stop the detection of open windows. The radiator will begin to function normally again and will restarts the detection of open windows.

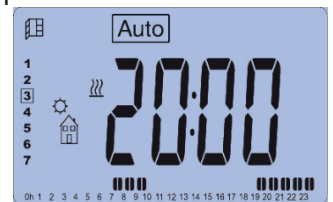

- MENU PARAMETERS

Your thermostat has a parameter's menu. To enter this menu, press and maintain the validation key (OK) for 5 seconds. Then the parameter menu will appear and the first menu screen will be displayed. Now you can select the parameters which must be adjusted with the navigation keys (). Press the (OK) key to edit the parameter that you wish to modify and change its value with (+) or (-), then confirm with (OK).



Nº Default value & other possibilities

1 **dEG:** Type of degrees displayed

°C Celsius

°F Fahrenheit

2 **24h:** Selection of the clock



24H (24:00)

12H (12:00 AM /PM)

3 **dSt:** Daylight summer time.

Yes the automatic change over time between Summer and Winter is activated according to date

No no daylight summer time automatic change.

- 4 **_ _**: Calibration of the internal probe
 The calibration must be done after 1 day working with the same setting temperature in accordance with the following description:
 Put a thermometer in the room at 1.5M distance from the floor (like the thermostat) and check the real temperature in the room after 1 hour.
 When you enter on the calibration parameter the actual value is displayed.
 To enter the value shown on the thermometer, use the (-) or (+) keys to enter the real value. Then, press (Ok) to confirm. The logo  should be displayed, to inform that a calibration is now made and saved in the memory. If you need to erase a calibration already made press on the navigation key left (). Then the logo must disappear.
 * Pay attention: Only the heating element managed by the thermostat must be used during the complete step of the calibration.
- 5 **AF**: Anti Freeze temperature:
 This Anti-freeze temperature used in Holiday mode.
 Adjustable 0.5 to 10.0°C with default value 5.0°C.
- 6 **ITCS**: Intelligent Temperature Control System
 The Intelligent Temperature Control System will activate your installation in advance (2 hours maximum) to assure the desired temperature at the hour programmed following your weekly program. This automatic control system works in the following way:
 When you start your thermostat for the first time, it will measure the time taken by your installation to reach the set temperature. The thermostat will re-measure this time at each program change to compensate external temperature change & influence. You can now program your thermostat without the need to adjust the temperature in advance because your thermostat does it automatically for you.
- 7 **WIN**: Automatic detection of open windows.
 This feature allows detect automatically if you open a window.
 No: deactivation of the function.
 Yes: Activate the function
- 8 **Clr**: Factory setting
 Press and maintain (Ok) key during 10s to reset Set points temperatures and user parameters in this menu to factory default settings. User programs will also be resetted.
 * Pay attention:
 Ensure that you have all necessary elements to re-setup your installation before to use this function.
- 9 Software version
- 10 **- -**
End: Exit the parameter's menu
 Press (OK) key to exit installation parameter menu and return to normal operation.

7. TECHNICAL CHARACTERISTIC

Measured temperature precision	0.1°C
Environmental: <ul style="list-style-type: none"> • Operating temperature • Shipping and storage temperature 	0°C - 40°C -10°C to +50°C
Setting temperature range <ul style="list-style-type: none"> • Comfort, Reduced • Timer 	5°C to 37°C by 0,5°C step 5°C to 37°C by 0,5°C step
Regulation characteristics	Proportional band (PWM)
Power Supply	230Vac +/- 10% 50Hz
Output <ul style="list-style-type: none"> • Maximum Load (Resistive only) 	TRIAC 230Vac 8 Amps (1850W)
Software Version	Displayed in the user menu.
Norms and directives: Your thermostat was designed in accordance with the following Europeans norms and directives:	EN 60730-1 : 2003 EN 61000-6-1 : 2002 EN 61000-6-3 : 2004 EN 61000-4-2 : 2001 Low voltage 2006/95/EC EMC 2004/108/EC

GB

8. TROUBLESHOOTING & SOLUTION

My Thermostat doesn't work	
Power supply	- Check the power supply
My Thermostat show an Error message "Err" blink on the display	
"Error" on sensor Note: For safety if there is a problem on the regulation sensor the regulation will be replaced by a rate of 5 % functioning.	 The logo and the text "Err" blinks. Error detected on the internal sensor - Contact your installer or seller.
My Thermostat seems work correctly but the heating doesn't work correctly	
Output	- Check the connections. - Check the power supply of the heating element. - Contact your installer.
My Thermostat seems work correctly but the temperature in the room was never in accordance with the program.	
Program	- Check the Clock. -The difference between Comfort & Reduced temperature is too high? - The step in the program is too short? - Check the pilot wire function.

9. INSTALLATION

• BEFORE INSTALLING

Whilst the installation of this heater is straightforward, please ensure you read the following carefully as the manufacturer will not be liable for any damage or problems arising from incorrect installation.

Unwrap your heater and clear the packaging away. The packaging has been specifically chosen to allow you to recycle it. If on unpacking, you discover any damage whatsoever, please get in touch with your supplier within 24 hours and prior to installation.

For assembly and installation, please follow the instructions as set out in this booklet. For safety reasons, this heater should never be installed in close proximity to a bath or shower i.e. that you could touch the controls whilst in the bath or shower. The radiator should not be placed below a socket. If the cable has been damaged, it can only be replaced by the manufacturer, through its aftersales team, or by a qualified person. This ensures the user will not be in any danger. At the end of the manual, you will find a Guarantee, please check that this has been completed correctly, dated and stamped

Very important:

- Read installation manual prior to installation of this unit!
 - Read user manual before putting this unit in operation!
 - Observe the warnings in the manuals!
 - The installation room must fulfil the ventilation requirements!
 - Installation by an authorised person only!
- CONNECTING ELECTRICITY SUPPLY
- If the Thermal Emitter that you have acquired does not have a plug on the supply cord, installation should be carried out by a qualified electrician.
 - Means for disconnection must be incorporated in the fixed wiring in accordance with the wiring rules of the country where it is to be installed.
 - Before connecting, check the supply is switched off.
 - Before connecting the appliance to the fixed wiring check that the voltage of supply is inside the rated values indicated in the marking plate 220 - 240V.
 - The appliance must be connected to the fused system of fixed wiring.
 - Any problem arising from not following the instructions above will invalidate your guarantee
 - When wiring up, please follow the colours of wires.

• HANGING THE HEATER

The radiator comes complete with an installation kit, comprising the following:

- Screws
- Brackets

Cardboard guide, (remove from the top of the box the radiator comes in). Please follow the illustrated steps below to hang and install your radiator:

1. Take the radiator out of its packaging and choose where to hang it. Please note the minimum distances required around the heater.
2. Remove the cardboard guide from the lid of the box and place it at the right height, as shown in diagram 4 below. We suggest you use a level to ensure the radiator is hung square. Using the holes as your guide, mark where the brackets need to go.
3. Drill and plug the holes.
4. Screw the brackets to hold the radiator into place, using the screws and washers provided.
5. Place the unit so that the brackets [15] fit into the slot that has the upper profile of the radiator.
6. Approximate the radiator to the holders of the wall brackets and screw fixation.
7. Use a hole drill for holes with appropriate stoppers for the type of wall.

GB

Read installation manual prior to installation of this unit!

- Read user manual before putting this unit in operation!
- Observe the warnings in the manuals!
- The installation room must fulfil the ventilation requirements!
- Installation by an authorised person only!

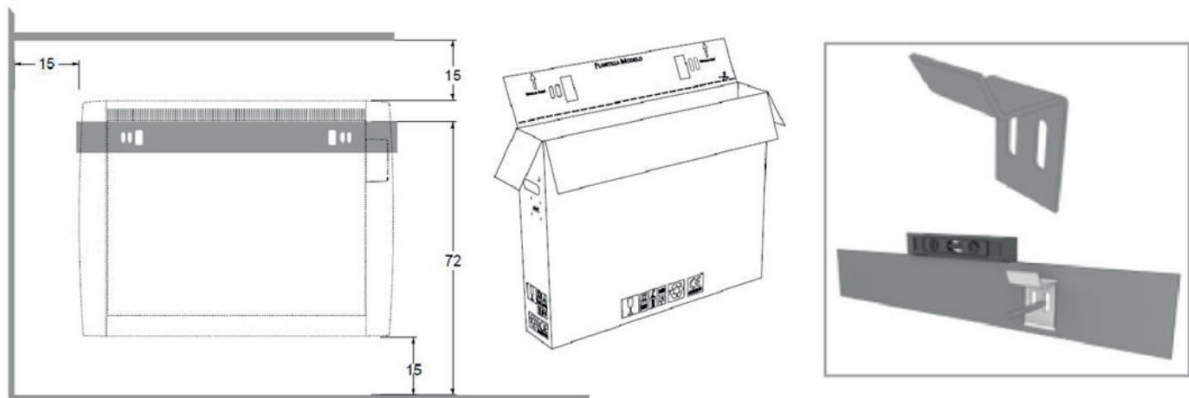

10. CONNECTING ELECTRICITY SUPPLY

- If the Thermal Emitter that you have acquired does not have a plug on the supply cord, installation should be carried out by a qualified electrician.
- Means for disconnection must be incorporated in the fixed wiring in accordance with the wiring rules of the country where it is to be installed.
- Before connecting, check the supply is switched off.
- Before connecting the appliance to the fixed wiring check that the voltage of supply is inside the rated values indicated in the marking plate 220 - 240V.
- The appliance must be connected to the fused system of fixed wiring.
- Any problem arising from not following the instructions above will invalidate your guarantee
- When wiring up, please follow the colours of wires

11. WIRING DIAGRAM

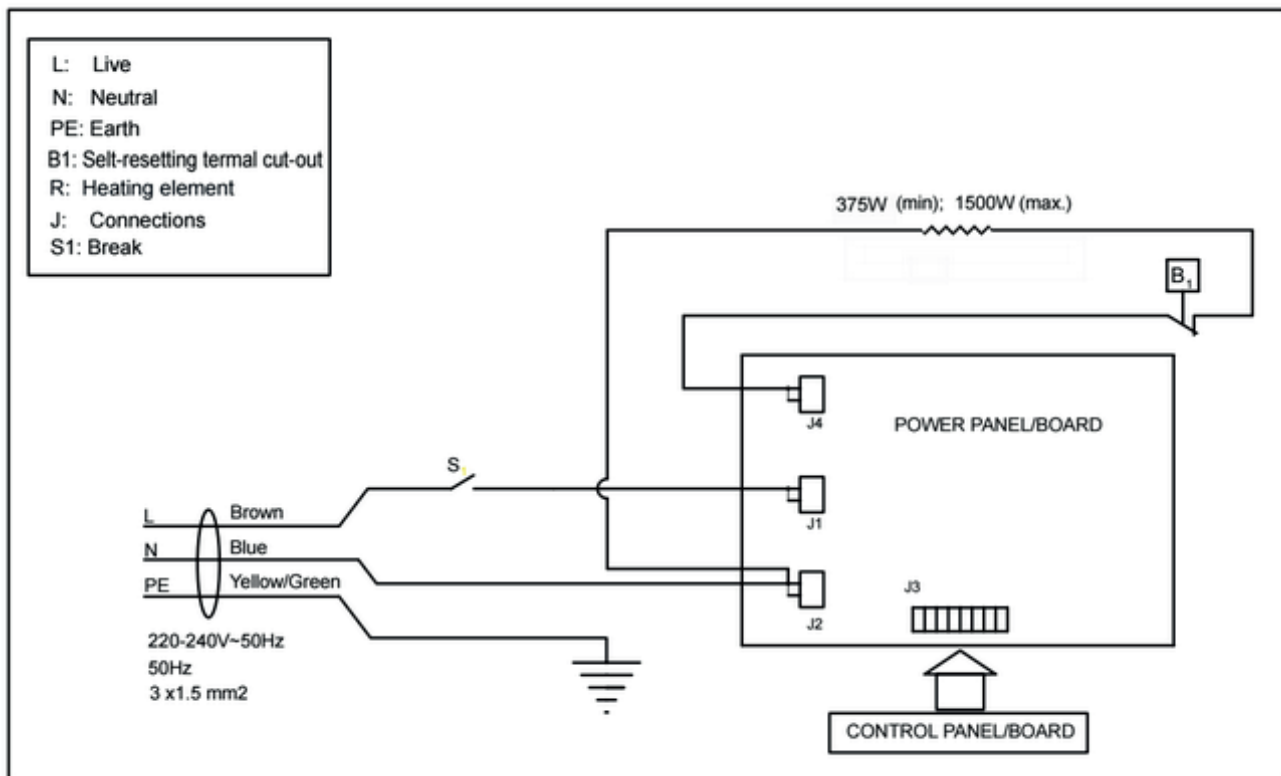

GB

12. GUARANTEE.

The manufacturer produces high quality products for international markets. The company provides a technical guarantee for the period of 2 years maximum. For this warranty to be valid you must present the original invoice, delivery note or ticket.

Prerequisites:

- The guarantee only covers manufacturing defects and/or any problem occurring from such defects. All problems arising from installing and undersized heater (not enough heat, improper installation, etc) are not covered by this guarantee.
- This heater is for domestic & light commercial use only, installation in any other environment voids this guarantee
- Technotherm reserves the right to decide whether to repair or replace any defective part or to replace the entire heater.
- All costs arising from any damage caused by incorrect usage, transport, electrical supply are not covered by this guarantee, nor is any malicious damage.

This guarantee does not provide compensation for incidental or consequential damage or injuries.

Information requirements for electric local space heaters

Model: PH SlimLine								
Item	Symbol	Value			Value		Item	Value
Heat output						Type of heat input, for electric storage local space heaters only (select one)		
Nominal heat output	P_{nom}	0,9	1,5	2,0	kW		manual heat charge control, with integrated thermostat	NO
Minimum heat output (indicative)	P_{min}	0,5	1,0	1,2	kW		manual heat charge control with room and/or outdoor temperature feedback	NO
Maximum continuous heat output	$P_{max,c}$	0,5	1,0	1,2	kW		electronic heat charge control with room and/or outdoor temperature feedback	NO
Auxiliary electricity consumption							fan assisted heat output	NO
At nominal heat output	$e_{l,max}$	0,9	1,5	2,0	kW		Type of heat output/room temperature control (select one)	
At minimum heat output	$e_{l,min}$	1,2	1,2	1,2	kW		single stage heat output and no room temperature control	No
		1,2	1,2	1,2		Two or more manual stages, no room temperature control	No	
In standby mode	$e_{l,SB}$	1,2	1,2	1,2	kW		with mechanic thermostat room temperature control	NO
		1,2	1,2	1,2		with electronic room temperature control	No	
							electronic room temperature control plus day timer	No
							electronic room temperature control plus week timer	Yes
							Other control options (multiple selections possible)	
							room temperature control, with presence detection	No
							room temperature control, with open window detection	Yes
							with distance control option	No
							with adaptive start control	Yes
							with working time limitation	No
							with black bulb sensor	No
Contact Information:	Lucht LHZ Elektroheizung GmbH & Co. KG Reinhard-Schmidt-Str.1 D-09217 Burgstädt							

GB

TECHNOTHERM a brand of Lucht LHZ GmbH & Co. KG
 Reinhard-Schmidt-Str. 1 | 09217 Burgstädt | Germany
 Telefon: +49 (0) 3724 66869 0
 Telefax: +49 (0) 3724 66869 20
 info@technotherm.de | www.technotherm.de

TECHNOTHERM Support
 +49 (0) 911 937 83 210

Subject to errors and technical amendments. Dimensions without guarantee! Edition 01/18